

From the IAUC President

Colleagues, I would like to draw your attention to the information on the **8th International Conference on Urban Climates (ICUC8)**, which will be held in Dublin between 6th-10th August, 2012 (see [page 20](#)). The conference website (www.icuc8.org) contains all the information of the scheduling of the event. Currently the call for abstracts is open and it will remain so until the end of the year (31st December 2011). Thereafter the abstracts will be reviewed by the scientific panel and a conference programme developed. Registration for the conference will open in January 2012 however, we would ask that colleagues register their interest in the event at the conference website if you want to receive regular updates on the progress of ICUC8. ICUC events have become the pre-eminent conferences at which research on the climate of cities and its application to urban design and planning are highlighted. I would urge members to advertise the event as widely as possible.

Inside the Fall issue...

2 News: [Preventable pollution](#) • [Greener concrete jungles](#) • [Tropical architecture](#)



5 Feature: [Modeling Tokyo with urban-scale Computational Fluid Dynamics](#)

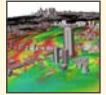

11 Projects: [Global expansion of urban areas – results from a meta-analysis](#)



14 Special Report: [ISUF 2011 – Urban morphology and the post-carbon city](#)



16 Bibliography: [Recent publications](#)
Conferences: [Fall/Winter gatherings](#)



20 IAUC Board: [The 8th International Conference on Urban Climates](#)

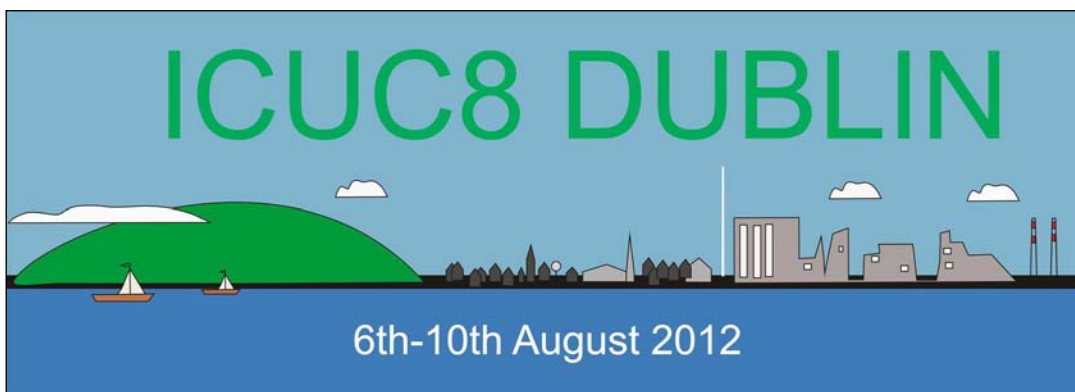

This is the 41st edition of *Urban Climate News*, which has proven to be a remarkable success story for the IAUC and provides the main means of communication between our global membership. We would like to develop the IAUC website (www.urban-climate.org) to complement Urban News by allowing for greater interaction among members. Over the coming months, a system will be introduced to the website that allows IAUC members to create profiles and participate in discussions on urban climate topics. In addition, we will make a concerted effort to develop the teaching resources. A part of this is the library of materials that represent classic studies in the field. Currently,

Luke Howard's *The Climate of London*, Tony Chandler's *Climate of London* and Albert Kratzer's *The Climate of Cities* are all available (as PDF files). I would like to add to this by republishing other studies that are classics but are difficult to obtain. I hope that we can have a conversation at ICUC8 on the development of the IAUC and its resources.



Gerald Mills
gerald.mills@ucd.ie

Preventable urban air pollution kills more than a million people each year – United Nations

September 2011 — More than one million lives could be saved each year if cities around the world adhered to United Nations guidelines on air pollution from cars and factories that can cause heart disease, lung cancer, asthma, and acute lower respiratory infections, according to a new UN report.

“Across the world, city air is often thick with exhaust fumes, factory smoke or soot from coal burning power plants, UN World Health Organization (WHO) Director for Public Health and Environment Maria Neira said of her agency’s “unprecedented” compilation of data from nearly 1,100 cities across 91 countries.

“In many countries there are no air quality regulations and, where they do exist, national standards and their enforcement vary markedly,” she added, calling for greater awareness of health risks caused by urban air pollution, implementation of effective policies and close monitoring of the situation.

WHO estimates that more than two million people die annually from breathing in tiny particles present in indoor and outdoor air pollution. PM10 particles, which are 10 micrometers or less, can penetrate the lungs and may enter the bloodstream, causing the diseases. WHO guidelines for PM10 is 20 microgrammes per cubic metre as an annual average, but the data show that in some cities this has reached up to 300 microgrammes. Only a few cities currently meet the guidelines.

For 2008, the estimated mortality attributable to outdoor air pollution in cities amounted to 1.34 million premature deaths, increasing from 1.15 million in 2004. If the WHO guidelines had been universally met, an estimated 1.09 million of those 2008 deaths could have been prevented, the agency said. The increase in the mortality is linked to recent increases in pollution and in urban population size, as well as improved data availability and methods employed.

“The most powerful way that the information from the database can be used is for a city to monitor its own trends in air pollution over time, so as to identify, improve and scale-up effective interventions,” said Carlos Dora, WHO’s Coordinator for Interventions for Health Environments.

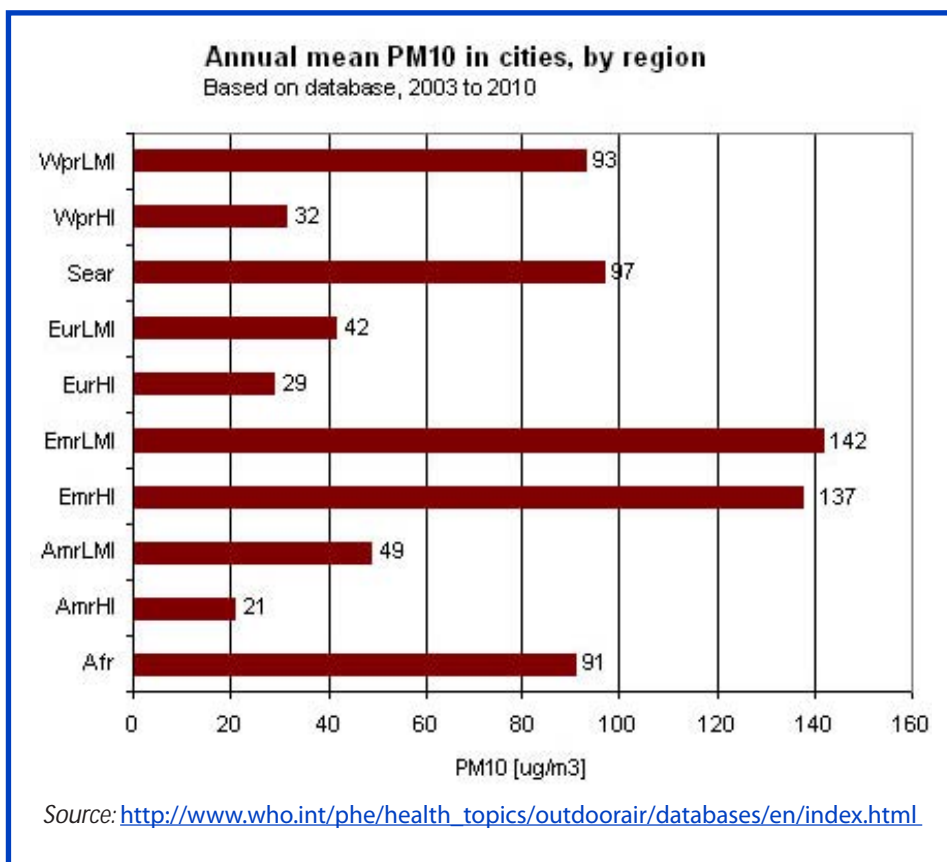

In both developed and developing countries, the largest contributors to urban outdoor air pollution include motor transport, small-scale manufacturers and other industries, burning of biomass and coal for cooking and heating, as well as coal-fired power plants. Residential wood and coal burning for space heating is an important contributor to air pollution.

“Local actions, national policies and international agreements are all needed to curb pollution and reduce its widespread health effects,” said Michal Krzyzanowski, Head of the WHO European Centre for Environment and Health.

“Data from air quality monitoring that is released today, identify regions where action is most needed and allows us to assess the effectiveness of implemented policies and actions.”

The data was compiled from publicly available national or city-specific sources, based on results of monitoring by individual cities at sites including roadsides, but excluding industrial and other recognized “hot spots” that are not representative of the exposure of many people so as to avoid overestimates.

Source: <http://www.un.org/apps/news/story.asp?NewsID=39825&Cr=pollution&Cr1=>

Greening the concrete jungle

America's cities are confronting climate change – and also saving money

September 2011 — There are many places in Illinois where you expect to find a prairie. The roof of City Hall in Chicago is not among them. Yet there it is—20,000 square feet (almost half an acre) of shrubs, vines and small trees, 11 storeys above LaSalle Avenue. Planted in 2000, City Hall's "green roof" reduces the amount of energy needed to cool the building in the summer; captures water during rainstorms, thus reducing the amount of water flowing into Chicago's already overtaxed sewers; and combats the urban "heat island" effect, which makes cities warmer than nearby rural areas. On average, air temperatures above City Hall are 10-15°F degrees lower than those above the adjacent black-tar roof of the Cook County Building; on hot summer days the difference can be as great as 50°F.

Large as it is, City Hall's roof accounts for a small proportion of Chicago's total green-roof space. And those roofs are just one part of Chicago's Climate Action Plan (CCAP), which was launched in September 2008 and was preceded by years of green initiatives during the tenure of Richard Daley, who from 1989 until earlier this year was mayor of Chicago. CCAP aims to reduce Chicago's greenhouse-gas emissions to 75% of their 1990 levels by 2020, and to just 20% of their 1990 levels by 2050. In the two years after CCAP's launch public-transport ridership rose, millions of gallons of water were conserved, hundreds of hybrid buses were added to Chicago's fleet and over 13,000 housing units and nearly 400



Source: [The Economist](#)

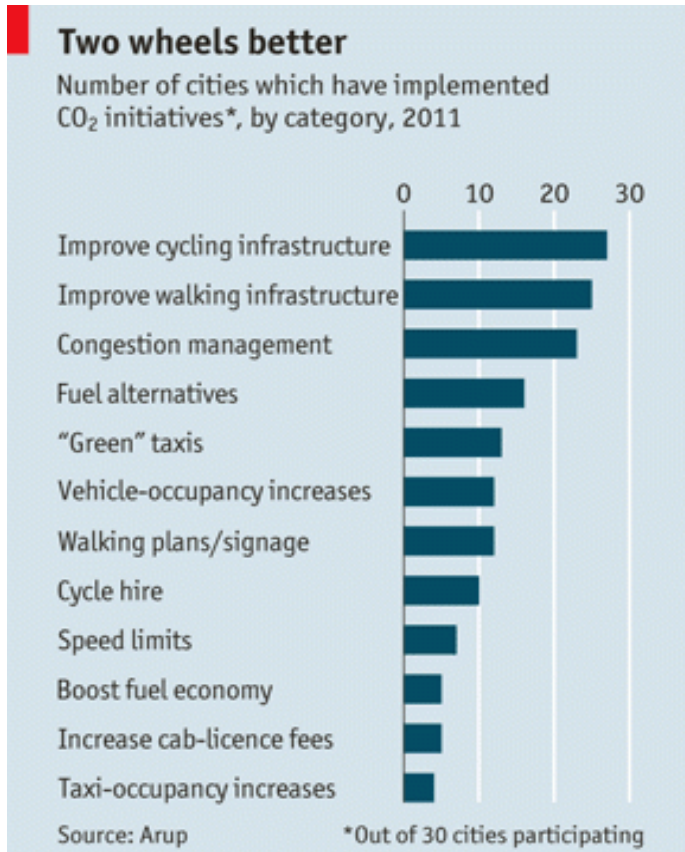

commercial buildings were retrofitted for energy efficiency.

These achievements have come not through sweeping social engineering, or by making Chicagoans dine on tofu, sprouts and recycled rainwater while sitting in the dark, but by simple tweaks. City buses inevitably need replacing; so why not replace them with hybrid models that are not only 60% lower in carbon emissions than standard diesel buses, but also 30% more fuel-efficient and will save an estimated \$7m a year in fuel and upkeep? Alleys—Chicago has 1,900 miles of them—will inevitably need repaving; why not repave them with permeable, light-coloured surfaces rather than asphalt to reduce water run-off into sewers and reflect rather than retain the sun's light and heat?

New York's ambitious PlaNYC had similar origins. It came about not because New York got green religion, but because the population, unlike that in most of America's other large, old, north-eastern cities, is growing. By 2030 9m people are forecast to live in New York, up from 8m in 2000 and almost 8.2m in 2010. The ways to accommodate such growth in an already dense and developed city inherently tend to be green: improving public transport, redeveloping brown-fields, making infrastructure and water supply more reliable and efficient.

Chicago and New York are just two of the ten American cities—the others are Austin, Houston, Los Angeles, New Orleans, Philadelphia, Portland, San Francisco and Seattle—

who are members of the Large Cities Climate Leadership Group (mercifully renamed the C40), which now comprises 58 cities around the world. Roughly 297m people, less than 5% of the Earth's total, live in the 40 charter-member C40 cities. But they account for 18% of the world's GDP and 10% of its carbon emissions. In total, cities house more than half the world's population, and account for two-thirds of its energy consumption and over 60% of its greenhouse-gas emissions.

These cities' plans vary. One particular strength of urban, as opposed to national or even state climate-change policy, particularly in a country as vast as America, is that cities are different; what works in one may not in another. Missy Stults, who until recently was climate director for ICLEI-USA, an NGO that works with local governments on the subject, says that for climate-change plans to work, "the actions you take have to be local", tailored to the particular needs of each city. Portland's plan, for instance, calls for 90% of its citizens to be able to walk or bicycle "to meet all basic, daily non-work needs" by 2030: a laudable and achievable goal there, but far more difficult in sprawling cities such as Los Angeles

or Houston. New York's PlaNYC pays more attention to wetlands and coastal issues than CCAP does, because New York has more coastline and waterways than Chicago.

But there are shared goals as well. All ten American C40-city plans have some sort of transport-policy aspect, whether public, such as switching to hybrid or electric taxis and buses, personal, such as encouraging cycling, or both. They try to reduce the amount of rubbish going to municipal landfills by encouraging composting and recycling; some push for converting waste into usable energy. Many propose more efficient outdoor lighting, which accounts for almost one-fifth of energy consumption across C40 cities and is mostly old and inefficient. And most plans push for retrofitting homes and offices to make them more energy-efficient—especially crucial in densely built cities such as New York, where buildings account for 75% of greenhouse-gas emissions.

These measures are not only environmentally sound. By and large they also save taxpayers money. This makes their benefits far more tangible than simply contributing to a good outcome in the distant future; and a much easier sell.

Source: <http://www.economist.com/node/21528272>

Green Architrends

Tropical architecture

Many confuse the term tropical architecture with a particular design style. In reality, tropical architecture is all about achieving thermal comfort through the use of passive design elements like sunshades, cavity walls, light shelves, overhangs, roof and wall insulation and even shading from large trees to block the sun. It can look very traditional, ultramodern or even high-tech.

Passive design is the process of achieving this comfort level without the use of mechanical systems. Tropical architecture is all about tackling the urban heat island effect.

So what exactly is the heat island effect? This phenomenon is what results from cities that have very little greenery and very many concrete surfaces. The city will have 2-3 degrees Celsius higher temperature than that of the surrounding suburbs and countryside. Figuratively, it forms an "island" of hotter land, while being surrounded by cooler land in the city outskirts.

Dark-colored roofs add to the heat island effect. Some of the heat absorbed by dark-colored roofs is transmitted to the room or space below.

Basic design principles. For the Philippines, having a warm humid climate, there are a few basic design principles regarding natural ventilation to cool a home or a building:

- The external features of the building envelope and its relation to the site should be ed to fully utilize air movement. Interior partitions should not block air movements.
- Air velocity can be reduced when the interior walls are placed close to the inlet opening or each time air is diverted around obstructions.
- If interior walls are unavoidable, air flow can still be ensured if the partitions have openings at the lower and upper portions.



This is a common strategy in the old Filipino *bahay na bato*, with its transom panels covered with intricate wood carvings or wood louvers.

- Maximize window openings for cross ventilation of internal spaces. Vents in the roof cavity can also be very effective in drawing out heat from the room interiors.
- Since hot air goes upward, and cool air goes downward, openings at the top of staircases and in clerestory

windows facilitate air change.

- It is generally cooler at night, so ventilation of internal spaces can be continuous for nighttime cooling. This means designing the building with operable windows to let hot air escape at night and to capture prevailing night winds.
- To supplement natural ventilation, fans can be placed at various heights and areas to increase comfort conditions. Fans are effective in generating internal air movement, improve air distribution and increase air velocities.
- Window openings are advisable at the body level for evaporative human body cooling. And room width should not exceed five times ceiling height for good air movement.
- Sunshades and sun protection devices on openings reduce heat gain and glare, and also help in internal daylighting. Louvres that are adjustable can alter the direction of air flow and lighting.
- Asian houses have big roof overhangs to protect interior spaces from heat gain and glare. Shading materials should reflect heat, and not be another source of heat.
- Roof insulation is a must in our warm climate. This reduces the temperature significantly inside the house.

For comments or inquiries, email Amado de Jesus of the Philippine Daily Enquirer (amadodejesus@gmail.com). Source: <http://business.inquirer.net/19613/tropical-architecture>



Urban-scale CFD modeling in Tokyo

By Yasunobu Ashie (ashie-y92ta@nilim.go.jp)

National Institute for Land and Infrastructure Management, Tsukuba, Ibaraki, Japan

Recently, countermeasures against the urban heat island effect have become increasingly important in Tokyo. Such countermeasures include reduction of anthropogenic heat release and enhancement of urban ventilation. Evaluations of urban ventilation require the construction of high-resolution computational fluid dynamics (CFD) models, which take into account complex urban morphology. The morphological complexity arises from multi-scale geometry consisting of buildings, forests, and rivers, which is superimposed on varying topography. Given this background, airflow and temperature fields over the 23 wards of Tokyo were simulated with a CFD technique using a total of approximately 5 billion computational grid cells with a horizontal grid spacing of 5 m (Ashie and Kono, 2011). The simulation results reproduced air temperature tendencies found in the observations such as lower air temperatures in coastal areas, rivers, and green spaces, and higher air temperatures in built-up areas. The RMS error between the simulation results and observations was 1.1 °C.

1. Numeric heat island model

Buildings, trees, etc. are complexly located in urban areas, and heat and momentum are transported inside and above the urban areas. Parts of cities vary in scale, and it is impossible to handle all parts uniformly as a result of limitations on computing resources. So it is usually necessary to give up efforts to perform direct resolution of all parts to perform rough visualization in grid cell units. And because grid cell width and the scale of the analytic range depend on the purpose, modeling must be done according to the purpose.

There are broadly three types of numerical model: the meso scale model, canopy model, and CFD (Computational Fluid Dynamics) model. Figure 1 organizes the grid cell resolution and analyzed scale (horizontal direction) of these numerical models. CFD has fine grid cell resolution, but it is generally believed that its analyzed scale is narrow. The meso scale model has coarse grid cell resolution, but it easily handles a wide area so it is applied to weather prediction. The canopy scale is in a position between the two other methods.

The only way to handle the layout and shapes of actual buildings in detail is to use CFD. The meso scale model and canopy model are, in principle, not suited for the detailed analysis of the interior of urban regions. Therefore, they are distinguished assuming that there is a “gap” in the modeling principle near grid cell resolution of 10m on the figure. To overcome this “gap”, expanding the analyzed range of CFD or nesting it with a different type of model such as a meso scale model are considered. The latter has been the object of many research projects, so this paper will discuss the potentiality of wide area CFD analysis.

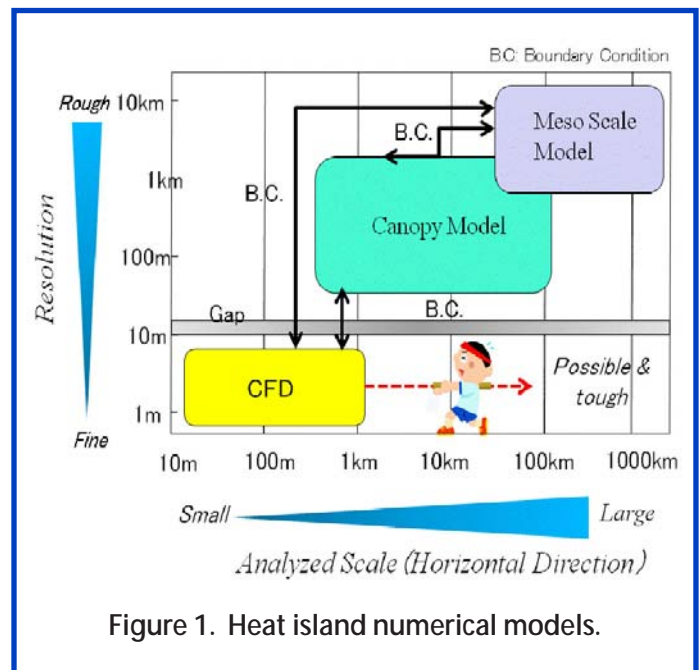

Figure 1. Heat island numerical models.

2. Significance of urban-scale CFD modeling

Wide-area CFD analysis is performed from two perspectives. One is academic interest in the urban boundary layer. Figure 2 shows the distribution of wind and air temperature in 1km squares. When the meso scale model is used, its scale is represented by 1km grid cells. But in fact, there are many buildings and roads in this district, resulting in considerable scattering according to land use and topography. If wide area calculations are done considering these complex three-dimensional shapes, what kinds of phenomena will appear in the urban boundary layer? This is the first perspective.

The second perspective is application to urban de-

sign. A close examination of Figure 2 reveals that wind flows along a winding river. But on corners of the bends, the wind flows directly ahead into urban districts without change. At such locations, the temperature is about 1°C lower than in other urban districts, and many such cases are seen around rivers. Information obtained from wide area CFD analysis plays an extremely important role in the introduction of passive cooling effects into urban design.

3. CFD analysis of all 23 Wards of Tokyo

Calculation Codes – Table 1 shows an outline of the calculation codes. The turbulence model is the standard k-ε model. Potential temperature, the Coriolis force and the turbulence caused by trees and so on were involved in the equations for the application to wide area analysis.

Table 1. Governing equations and numerical schemes for the CFD model.	
Component	Content
Governing equations	<ul style="list-style-type: none"> • Mass conservation equation • Momentum transport equation (buoyancy, Coriolis force and drag of trees considered) • Energy transport equation (formulated in terms of potential temperature; sensible heat from walls and anthropogenic heat are considered) • Water vapor transport equation (formulated in terms of specific humidity; latent heat released from walls and anthropogenic heat are considered) • Transport equation for turbulence kinetic energy (k) (turbulence generated by buoyancy, humidity and trees is considered) • Equation for rate of dissipation of turbulence kinetic energy (ϵ) (dissipation by buoyancy, humidity and trees is considered) <p><i>* In order to take into account objects smaller than the grid resolution, all equations are formulated with the FAVOR technique.</i></p>
Turbulence model	Standard k - ϵ model
Coordinate system	Three-dimensional orthogonal coordinate system
Computational grid	Staggered grid
Discretization method	Finite Difference Method
Spatial discretization	1st-order upwind scheme (advection term), 2nd-order central difference scheme (others)
Time discretization method	Fully implicit scheme
Calculation algorithm	AMG-CG solver, BiCGSTAB solver

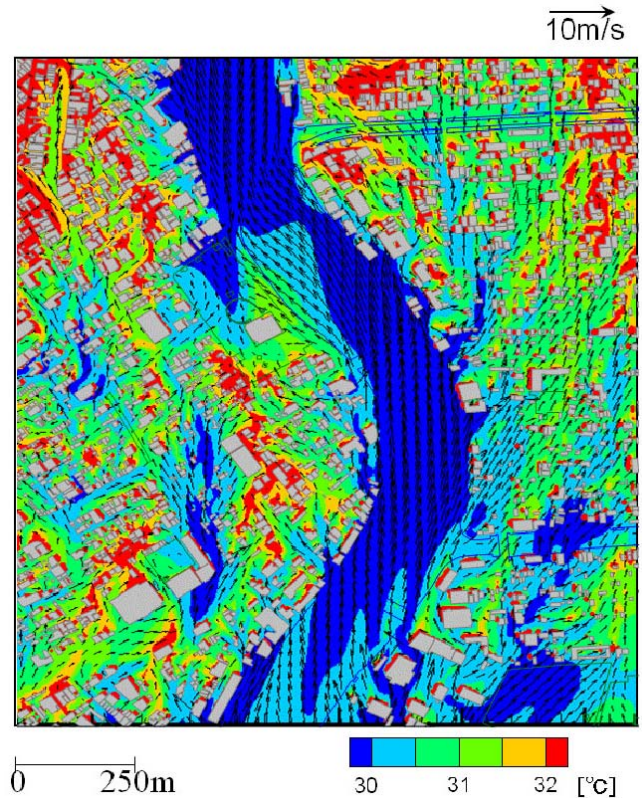

Figure 2. Air temperature and wind around the Sumida river (height of 10m above ground level).

Calculation flow – Figure 3 shows the flow of the over-all calculation. It is designed so that grid cell data and boundary conditions adopted to present conditions or the development plan are provided and entered to the analysis program and output air temperature, wind speed, and other environmental factors.

CFD analysis is enforced under steady condition. Some physical quantities such as air temperature, wind speed, pressure etc. are fixed as boundary conditions of the air above and of the sides for the date and time. These physical quantities are obtained by first performing one-day calculations based on a meso scale model.

The ground surface and sunshine and shade around buildings are judged for each analysis cell based on the three-dimensional city shape and location of the sun. Daily change of ground surface temperature is obtained by a one-dimensional heat conduction unsteady model considering heat balance for each covering. Using numerical results, the ground surface temperature for that date and time is fixed for each CFD analytical cell.

CFD calculation – The CFD analytic domain is shown in Figure 4 with the elevation distribution. The object in this case is a horizontal 33km square including the 23 wards of Tokyo, and the upper edge in the vertical direction is elevation of 500m. There are between 1.6 and 1.7 million buildings in the 23 wards of Tokyo. The drop of the elevation in the analytic range reaches 80m. The space is divided into 5m horizontal grid cells and verti-

cally between 1 and 10m, and a buffer region of 1.5km is placed around the analytical range. Using a high speed supercomputer named the Earth Simulator (Japan Agency for Marine Earth Science and Technology), a total of about 5 billion grid cells (including the buffer range), 300 calculation nodes, and 16 hours were required. The spatial scale of the domain in the present simulation is one of the largest ever investigated in an urban CFD study (see Table 2).

Figure 5 (left) shows the results of calculating the air temperature at a height of 10m above the ground. In this time period, the south wind was almost always dominant, and the air temperature increased downwind to the north. The air temperature was particularly high from Nerima to Saitama. On the other hand, it shows that on the seaside part of the right side of the analytical range, the air temperature was relatively low.

A close examination of the air temperature distribution shows that stripe-shaped high temperature areas are partially formed. These thermal stripes lie from south to north and are distributed along the regional wind direction. As shown in Fig. 5 (right), many stripe-shaped high temperature areas are formed along trunk roads running in the south-north direction. The traffic volume is heavy and buildings are also concentrated along trunk roads, resulting in large artificial heat exhaustion

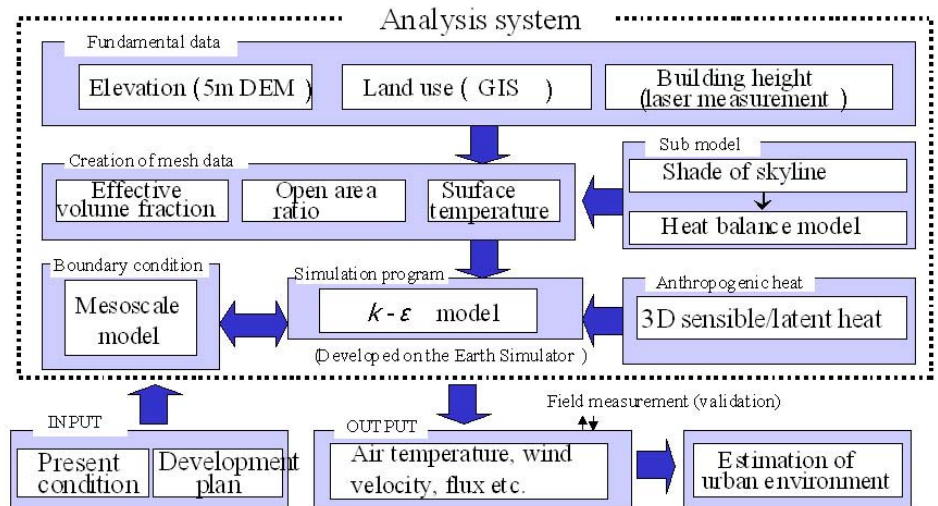

Figure 3. Diagram of urban heat island analysis.

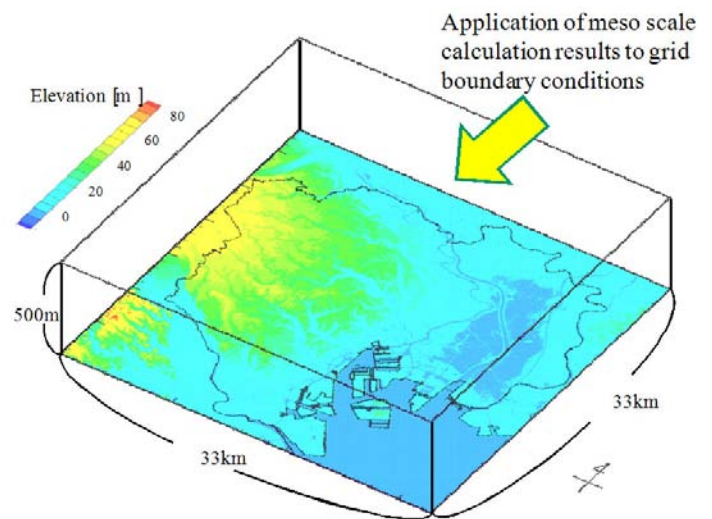

Figure 4. CFD analytical domain.

Table 2. Examples of recent CFD simulations that resolve individual buildings in urban areas.

Literature	Application (turbulence model)	Horizontal domain size [m ²]	Vertical domain height [m]
Ashie & Kono (2011)	Thermal environment (RANS)	33000 x 33000	500
Baik <i>et al.</i> (2009)	Pollution dispersion (RANS)	980 x 1140	500
Blocken & Pearson (2009)	Wind environment (RANS)	3000 x 3000	500
Bou-Zeid <i>et al.</i> (2009)	Wind environment (LES)	1500 x 1500	500
Hanna <i>et al.</i> (2009)	Pollution dispersion (RANS)	Approximately 3200 x 900	Approximately 650
Xie & Castro (2009)	Pollution dispersion (LES)	1200 x 800	200
Nozu <i>et al.</i> (2008)	Wind load (LES)	2048 x 1024	800
Oguro <i>et al.</i> (2008)	Wind environment (RANS)	10000 x 10000	400
Tamura (2008)	Wind load (LES)	2900 x 1200	1000
Burrows <i>et al.</i> (2007)	Wind environment (RANS)	2100 x 2100	300
Chan <i>et al.</i> (2007)	Pollution dispersion (RANS)	1030 x 3010	425
Flaherty <i>et al.</i> (2007)	Pollution dispersion (RANS)	900 x 1200	300
Hendricks <i>et al.</i> (2007)	Pollution dispersion (RANS)	1400 x 1400	200
Huang <i>et al.</i> (2005)	Thermal environment (RANS)	400 x 400	450

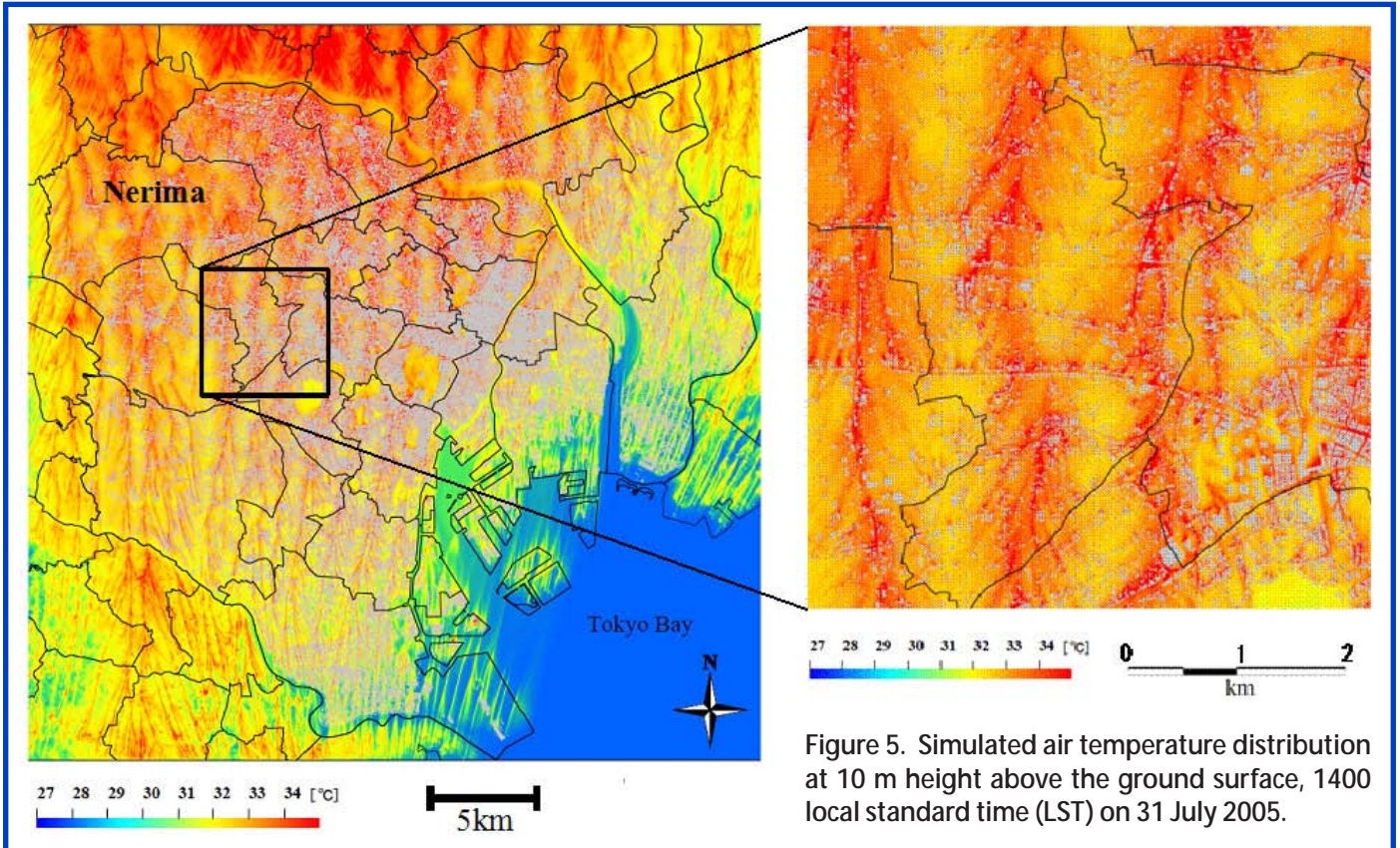

Figure 5. Simulated air temperature distribution at 10 m height above the ground surface, 1400 local standard time (LST) on 31 July 2005.

and the action of the wind blocking effects of the building walls.

It is assumed that the concentration of these factors in the region impacts the formation of the air temperature. It is possible to perceive that the stripe-shaped high temperature areas link surrounding high temperature areas in a ramiform pattern, and are concentrated and develop while heat near the ground surface is transported by an advection flow.

Comparison with observations – The results of the current analysis can be compared to two sets of simultaneous large-scale meteorological observations: those made by the Metropolitan Environmental Temperature

and Rainfall Observation System (METROS) which is managed by the Tokyo metropolitan government, and those from an observational campaign conducted by the National Institute for Land and Infrastructure Management (NILIM) in collaboration with Waseda University, Tokyo Metropolitan University, and the Nippon Institute of Technology. Specifically, the simulated air temperatures are compared to the METROS air temperature data collected at 127 observation shelters (Stevenson screens) located at elementary schools across the 23 wards of Tokyo and to the NILIM campaign air temperature data collected at 173 locations in the coastal area of Tokyo Bay.

Figure 6 compares the horizontal distribution of air

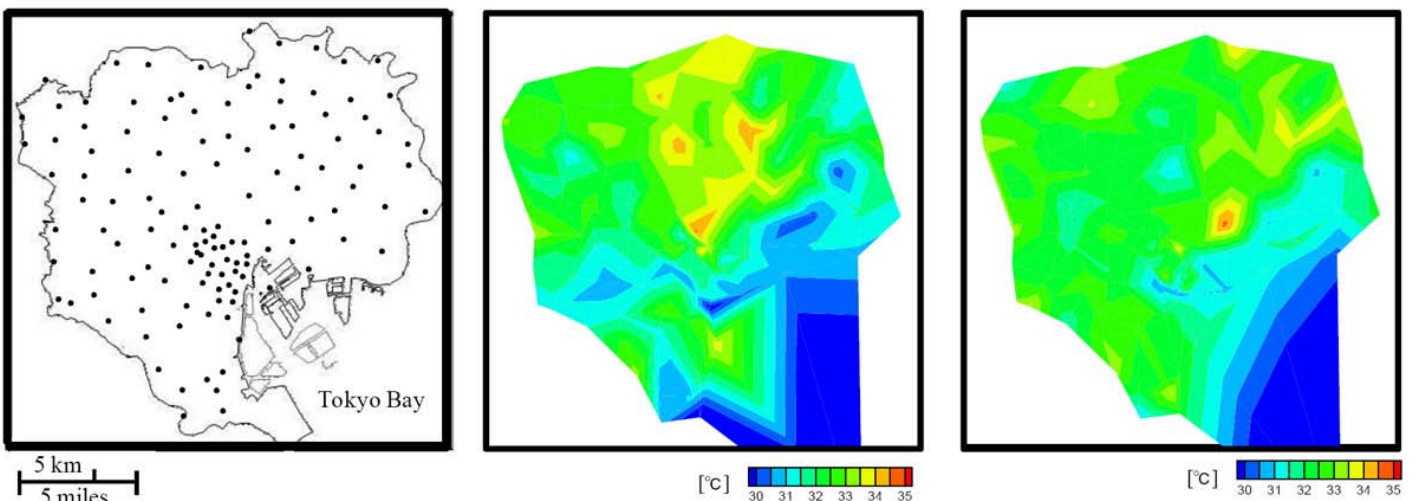

Figure 6. Air temperature distribution at the 127 METROS observation points, 1400 LST on 31 July 2005.

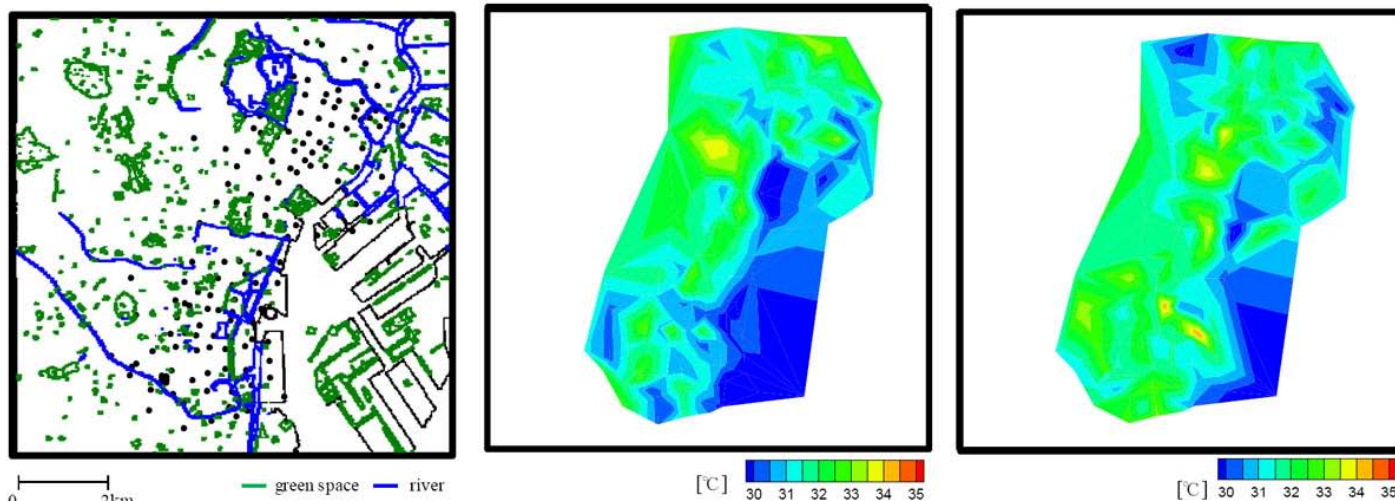

Figure 7. Air temperature distribution at the 173 points of NILIM observation campaign, 1400 LST on 31 July 2005.

temperatures observed at the 127 observation sites operated by METROS to the air temperatures simulated at the same locations by the model. The simulated air temperatures in this figure represent those from 2 m above the ground. The figure also includes data observed at one point over the sea ($35^{\circ} 27' 52.09''\text{N}$, $139^{\circ} 52' 28.35''\text{E}$) by the Ministry of the Environment (MOE). The simulation and observation results show the same tendency of low air temperatures in the coastal area and of high air temperatures in the central metropolitan area and its leeward areas. The RMS error between the simulation results and the METROS observations from the 127 points is 1.1°C .

Figure 7 compares the horizontal distribution of air temperatures observed at the 173 sites by the NILIM observation campaign to the air temperatures simulated at the same locations by the model. The simulation results shown in the figure are from 5 m above the ground, while the NILIM campaign observations were conducted from 3 to 5 m above the ground. Although the observations were conducted mainly along streets, both the simulation results and observations clearly show the same tendency of low air temperatures near rivers and green spaces and of high air temperatures in built-up areas. The RMS error between the simulation results and the NILIM campaign observations from the 173 points is 1.1°C .

4. Conclusions

A large scale calculation of several billion cells was possible, reproducing the sea wind inflow phenomenon in the bay region along with wind flowing through urban spaces. This revolutionary new analytical technology will provide us with highly realistic environmental information such as that shown in Figure 8.

But according to the state of development of the actual convective mixed layer, this analytical result does not ensure adequate height, so it is a steady calculation which means there is a methodological limit to following

diurnal change. In the future, we must make improvements to this urban model by linking it to a meso scale model in order to be able to apply it to resolve unsteady CFD problems.

ACKNOWLEDGEMENTS

The present research was conducted as a part of a research assignment funded by the "Grant for Operating Costs" of the Building Research Institute (BRI) and also as a part of a collaborative project with the Earth Simulator Center of the Japan Agency for Marine-Earth Science and Technology (JAMSTEC).

References

- Ashie Y, Kono T. 2011. Urban-scale CFD analysis in support of a climate-sensitive design for the Tokyo Bay area, *International Journal of Climatology*, 31-2: 174–188.
- Baik JJ, Park SB, Kim JJ. 2009. Urban flow and dispersion simulation using a CFD model coupled to a meso-scale model. *Journal of Applied Meteorology and Climatology* 48: 1667–1681.
- Blocken B, Persoon J. 2009. Pedestrian wind comfort around a large football stadium in an urban environment: CFD simulation, validation and application of the new Dutch wind nuisance standard. *Journal of Wind Engineering and Industrial Aerodynamics* 97: 255–270.
- Bou-Zeid E, Overney J, Rogers BD, Parlange MB. 2009. The effects of building representation and clustering in large-eddy simulations of flows in urban canopies. *Boundary-Layer Meteorology* 132: 415–436.
- Burrows DA, Hendricks EA, Diehl SR, Keith R. 2007. Modeling turbulent flow in an urban central business district. *Journal of Applied Meteorology and Climatology* 46: 2147–2164.
- Chan ST, Leach MJ. 2007. A validation of FEM3MP with Joint Urban 2003 data. *Journal of Applied Meteorology and Climatology* 46: 2127–2146.

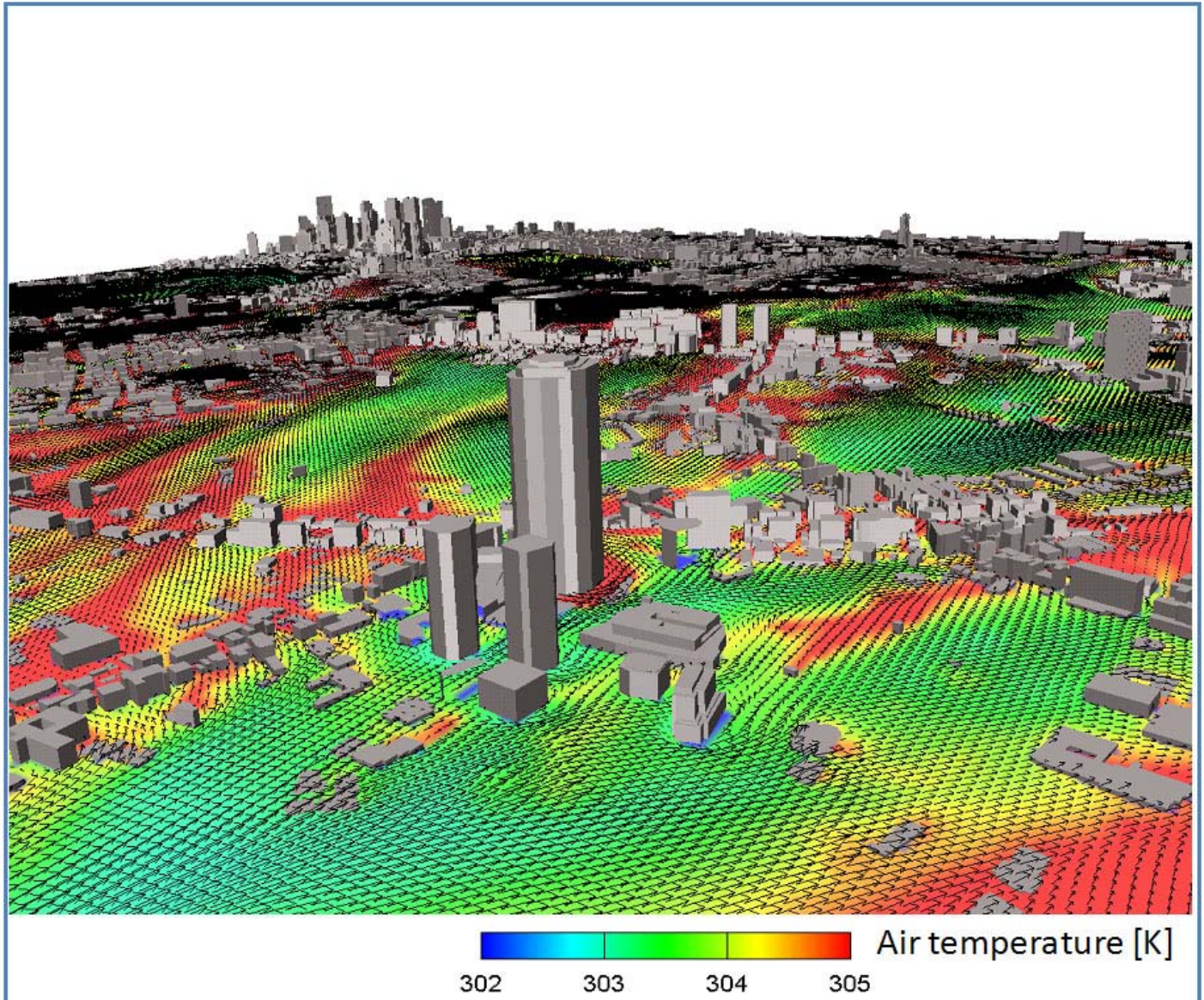

Figure 8. Example of wide area CFD analysis.

Flaherty J, Stock D, Lamb B. 2007. Computational fluid dynamics simulations of plume dispersion in urban Oklahoma city. *Journal of Applied Meteorology and Climatology* 46: 2110–2126.

Hanna SR, Hansen OR, Ichard M, Strimaitis D. 2009. CFD model simulation of dispersion from chlorine railcar releases in industrial and urban areas. *Atmospheric Environment* 43: 262–270.

Hendricks EA, Diehl SR, Burrows DA, Keith R. 2007. Evaluation of a fast-running urban dispersion modeling system using joint urban 2003 field data. *Journal of Applied Meteorology and Climatology* 46: 2165–2179.

Huang H, Ooka R, Kato S. 2005. Urban thermal environment measurements and numerical simulation for an actual complex urban area covering a large district heating and cooling system in summer. *Atmospheric Environment* 39: 6362–6375.

Nozu T, Tamura T, Okuda Y, Sanada S. 2008. LES of the

flow and building wall pressures in the center of Tokyo. *Journal of Wind Engineering and Industrial Aerodynamics* 96: 1762–1773.

Oguro M, Morikawa Y, Murakami S, Matsunawa K, Mochida A, Hayashi H. 2008. Development of a wind environment database in Tokyo for a comprehensive assessment system for heat island relaxation measures. *Journal of Wind Engineering and Industrial Aerodynamics* 96: 1591–1602.

Tamura T. 2008. Towards practical use of LES in wind engineering. *Journal of Wind Engineering and Industrial Aerodynamics* 96: 1451–1471.

Xie Z-T, Castro IP. 2006. LES and RANS for turbulent flow over arrays of wall-mounted obstacles. *Flow, Turbulence and Combustion* 76: 291–312.

Xie Z-T, Castro IP. 2009. Large-eddy simulation for flow and dispersion in urban streets. *Atmospheric Environment* 43: 2174–2185.

Global expansion of urban areas: Results from a meta-analysis

Much has been written about the ongoing and forthcoming urban demographic transition at global scales. We know from the United Nations that more people live in urban areas than other types of settlements and that this trend will continue for the foreseeable future (UN, 2008). Moreover, recent projections show that world population could reach 10.1 billion by 2100, and that much of the growth in population between now and then is likely to take place in just 58 countries, 39 of which are in Africa (UN, 2011).

In contrast, the study of the physical component of urbanization – the conversion of land cover to urban uses – is less understood and characterized, especially at global scales. Most of our understanding of urbanization as a land change process is based on individual case studies of cities or metro regions, many of which use satellite data to map and monitor urban growth. Case studies of rapidly urbanizing places such as the Pearl River Delta and Yangtze River Delta in China, and sunbelt cities in the US such as Las Vegas and Phoenix,

have gained a lot of attention from media and researchers. Yet, we know considerably less about the patterns and rates of urban expansion globally. What is becoming clear from these individual case studies is that there are significant differences in urbanization processes among regions and countries, and even within countries; urbanization as a physical phenomenon is not a homogeneous process (Seto *et al.*, 2010).

Using a meta-analysis of 326 studies that have used remotely sensed images to map urban land conversion (see Fig. 1), we find that urban land expansion rates are higher than or equal to urban population growth rates for all regions of the world from 1970 to 2000 (see Figs. 2 and 3). India, China, and Africa have experienced the highest rates of urban land expansion, but the largest change in total urban extent – as reported in the peer-reviewed English language literature – has occurred in North America. This could reflect a sampling bias because 16% of the urban areas in the meta-analysis are in North America.

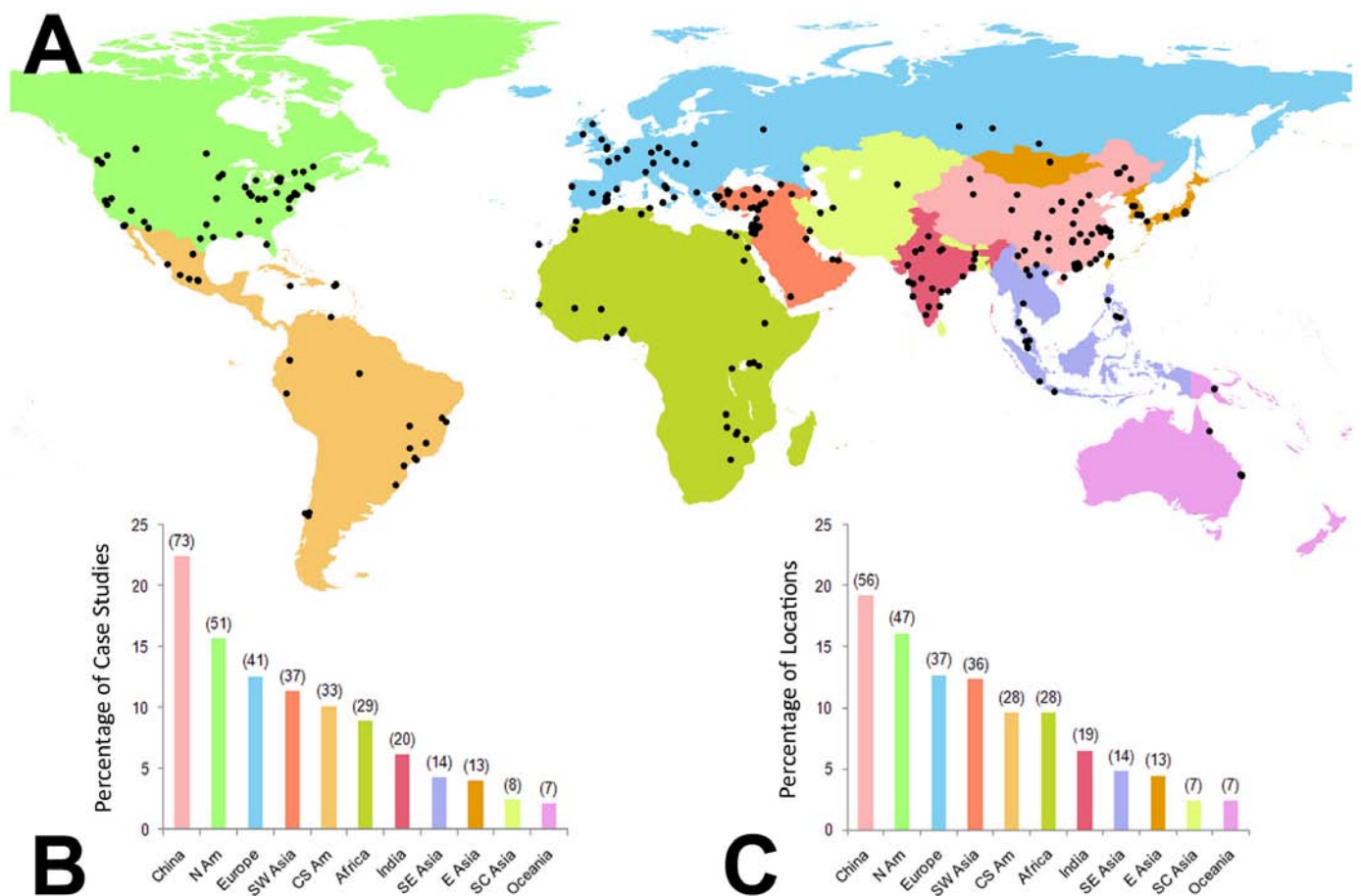

Figure 1. Geographical distribution of case studies and their locations. **A**, Locations of case studies. **B**, Studies by region. Numbers in parentheses are the number of case studies for each region. The total number of case studies is 326. **C**, Locations by region. Numbers in parentheses are the number of locations for each region. The total number of unique locations is 292. There are more case studies than geographic locations because there may be multiple case studies on a single location. The color-coding for the map corresponds to the bar charts. [doi:10.1371/journal.pone.0023777.g001](https://doi.org/10.1371/journal.pone.0023777.g001)

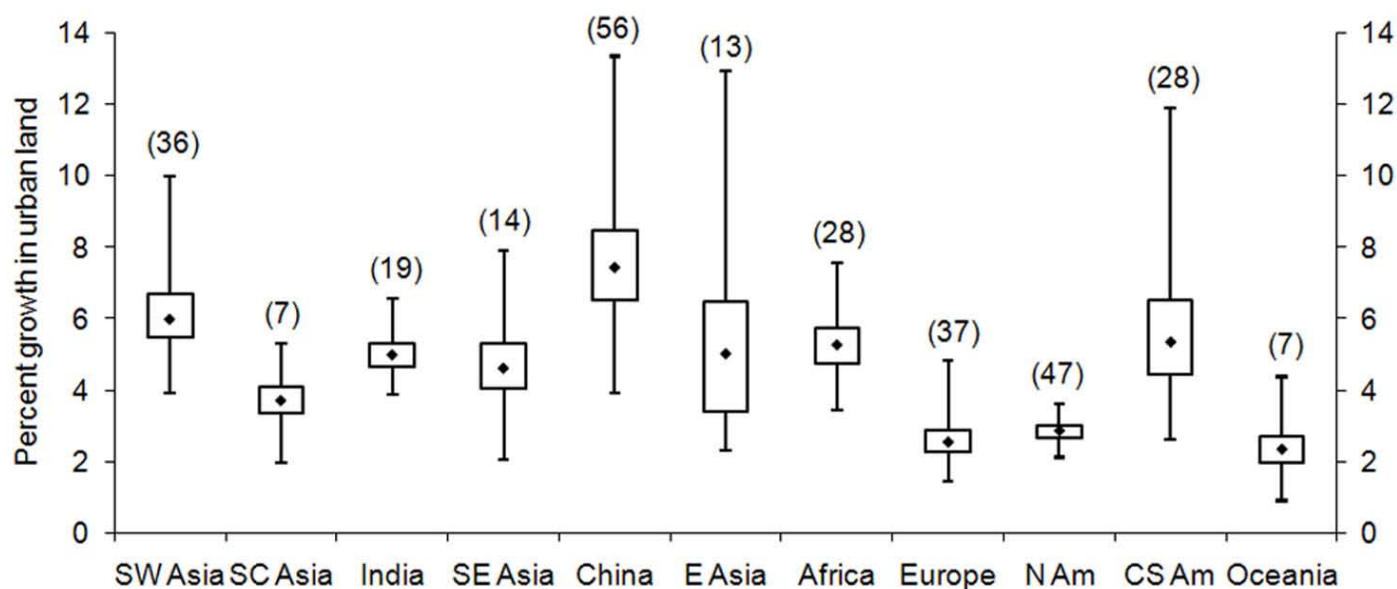

Figure 2. Average annual rates of urban expansion by region (1970–2000). Box plots show the median, 1st and 3rd quartiles, minimum and maximum values of bootstrapped average annual rates of urban expansion by region. doi:10.1371/journal.pone.0023777.g002

In fact, one of the unexpected results of the study is the finding that some of the largest urban areas worldwide are not being studied in terms of their changing urban land extent, or at least not being reported in English language journals. Surprisingly, five of the world’s most populated cities, Dhaka, Karachi, Kolkata, Jakarta, and Delhi, were not represented in the meta-analysis case studies. This points to the need for new analyses and ongoing monitoring of urban expansion for a larger typology of urban areas worldwide.

Our analysis shows that total change in urban extent for the meta-analysis case studies was 58,000 km², an area approximately 1.3 times the size of Denmark. While this figure may appear relatively small, especially compared with estimates of deforestation, it is important to note that this estimate is based on the reported results in the published literature. In actuality, urban expansion from 1970 to 2000 is likely to be much higher given that the published studies are biased towards the larger cities and

not smaller settlements. In other words, this figure is likely an underestimate of the actual amount of urban expansion during this period.

We then examined potential global urban expansion for 2030 based on the meta-analysis results, global population projections, GDP projections, and estimates of contemporary urban extent (see Table 1). There are large variations in the latter: 2001 estimates using the MODIS satellite suggest that global urban extent is 726,943 km². In contrast, estimates from the Global Land Cover 2000 dataset are less than half the size (307,575 km²), while the 2000 GRUMP dataset from the Center for International Earth Science Information Network at Columbia University provides an estimate nearly five times that of MODIS extent (3,524,108 km²). Our models show a global increase in urban land cover in 2030 of between 430,000 and 12,568,000 km², with a figure of 1,527,000 km² more likely. For a more complete treatment of the topic, see our recently published analysis in *PLoS One* (Seto et al., 2011).

Table 1. Forecasts of Additional Urban Land Area by 2030 Using SRES Scenarios¹

Baseline data set	Baseline urban extent (km ²)	Additional Urban Land Area by 2030 (km ²)			
		A1	A2	B1	B2
MODIS 2001 ²	726,943	2,255,576	1,165,785	1,913,273	1,526,805
GRUMP 2000	3,524,108	12,568,323	5,734,517	9,818,872	7,619,054
GLC00 2000	307,575	857,528	429,865	719,188	586,177

¹SRES Scenarios derived from http://sres.ciesin.columbia.edu/final_data.html. ²Based on MOD12Q1 V004 Land Cover Map (<http://duckwater.bu.edu/lc/mod12q1.html>). doi:10.1371/journal.pone.0023777.t003

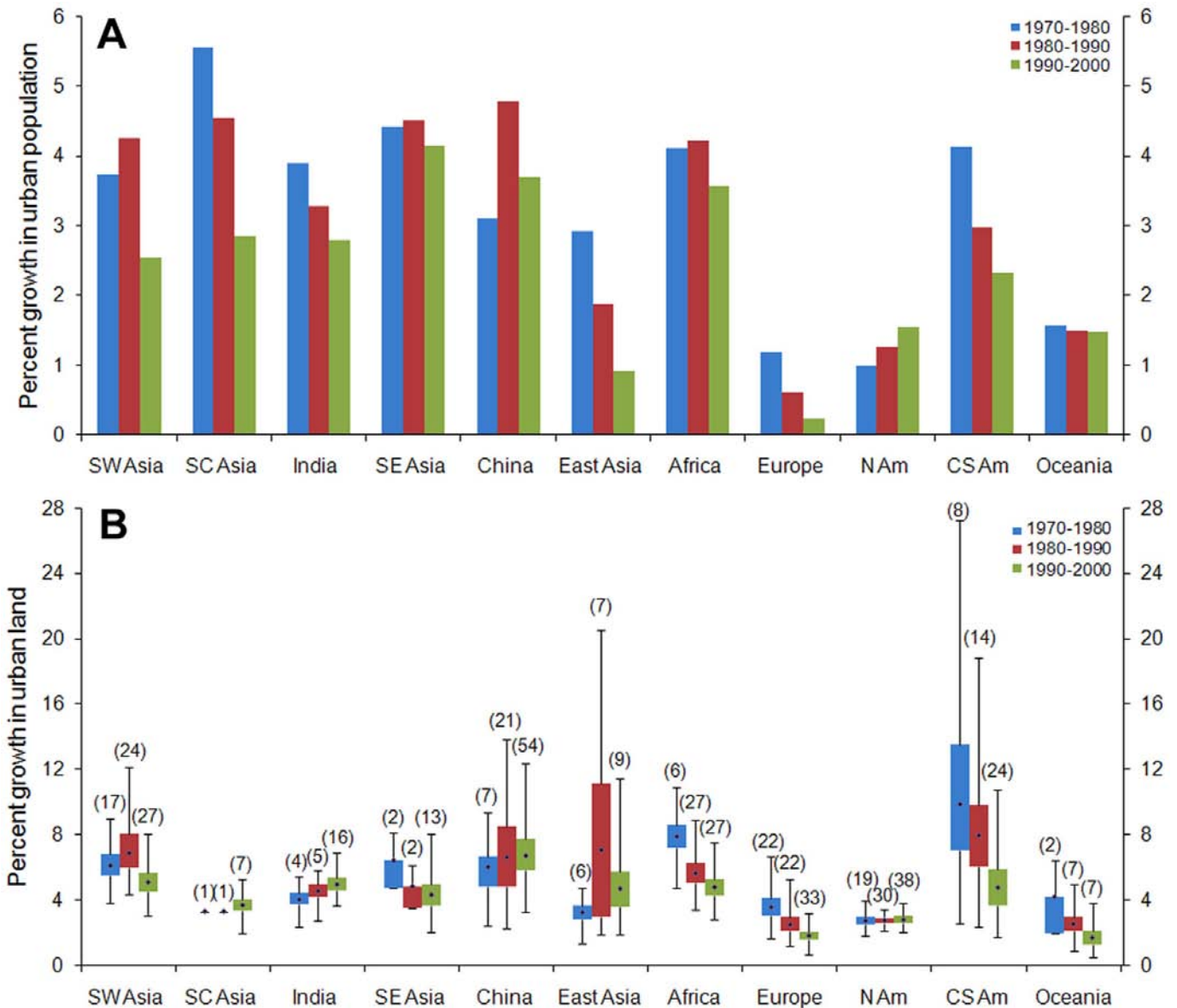

Figure 3. Comparison of two different urban growth measures by region and by decade. Annual rates of **A**, urban population change and **B**, urban land expansion. Population data are aggregated from individual countries to the geographic regions in the meta-analysis. Average annual rate of urban land change is based on the case studies in the meta-analysis. Box plots in B show the median, 1st and 3rd quartiles, minimum and maximum values of bootstrapped average annual rates of urban expansion by region. [doi:10.1371/journal.pone.0023777.g003](https://doi.org/10.1371/journal.pone.0023777.g003)

References

Seto, K. C., Fragkias, M., Güneralp, B., and Reilly, M. K. 2011. A meta-analysis of global urban expansion, *Plos One* 6(8): e23777. [doi:10.1371/journal.pone.0023777](https://doi.org/10.1371/journal.pone.0023777).

Seto, K. C., Sanchez-Rodriguez, R., and Fragkias, M. 2010. The new geography of contemporary urbanization and the environment, *Annual Review of Environment and Resources* 35: 167-194.

United Nations. 2008. *World Urbanization Prospects: The 2007 Revision*. New York: United Nations.

United Nations. 2011. *World Urbanization Prospects: The 2010 Revision*. New York: United Nations.



Karen C. Seto

Yale School of Forestry and Environmental Studies
karen.seto@yale.edu

The 18th International Seminar on Urban Form (ISUF2011): Urban Morphology and the Post-Carbon City

James Voogt

Dept. of Geography, University of Western Ontario

Michael van der Laan

Dept. of Geography, University of British Columbia

The 18th International Seminar on Urban Form (ISUF 2011) was held at Concordia University in downtown Montréal, Canada, on August 26-29, 2011. The conference used a new building that provided excellent presentation and seating arrangements within reasonably sized classrooms as well as good open spaces for discussions at coffee breaks. The conference fee of \$440/\$240 \$Cdn for regular and student participants included two conference social events, an ice breaker social hosted at the Canadian Centre for Architecture and a conference dinner held at a former public market building in Old Montréal. The conference location provided ready access to nearby restaurants and hotels for the participants.

The conference was organized into eight "streams", each consisting of multiple sessions of oral presentations. There were no poster presentations. The attendees come from a range of backgrounds including: Geography, Urban Planning, Architecture, and Engineering, reflecting the multidisciplinary basis of those interested in Urban Morphology. Of particular relevance to IAUC members were six sessions on "Urban Form and Environmental Performance". These sessions would not have been out of place at an ICUC and a number of these presentations were from current IAUC members. The relatively large number of sessions in this stream reflected an intentional emphasis from the conference organizers to try and get more urban climate related papers submitted to the conference. For the most part, the attendance at these sessions tended to be static, suggesting that those interested in these sessions were perhaps somewhat isolated from the other conference 'streams', but variations in how the total session time was managed also worked against easy 'session-hopping'. On the positive side, the relatively long question period (generally 4 papers per 90 minute session: 15 min presentation + 5 min question + 10 min general question and discussion period) provided excellent opportunities for additional questions and discussions for some papers.

The opening plenary session was given by Prof. Jeremy Whitehand of the Urban Morphology Research Group at the University of Birmingham. In it, he provided a historical context for the conference and discussed nine primary issues that face the study of Urban Morphology from a geographical-historical perspective. Among the issues addressed was the advice first attributed to Penck: "*When you see the particular, look for the general!*". This was an important statement for a truly interdisciplinary conference to foster communication between large numbers of interrelated disciplines in attendance.



Through the discussion of other issues, several themes emerged that may parallel some of those that face urban climatology and meteorology and the IAUC: the multidisciplinary background that characterizes participants of ISUF and the proliferation of cross-disciplinary relationships between urban morphology and other fields; an English language bias to international journals and citation indices; an over-representation of studies on European and American urban morphologies at the expense of other regions, notably Eastern Asia; a need for specific studies to generalize their research results, for comparative studies, and for an integrated approach (here in particular the linkage to urban atmospheres and its relation to urban form may be relevant); and a weak relationship between research and practice. It was suggested that urban morphology could and has played a role as a connective field through which disciplines such as urban climatology could communicate with the planning and architectural disciplines.

Although the conference spanned many disciplines and research interests, one common thread emerged – the interest in the shape of our cities and their influence on the inhabitants that live within city boundaries. Attendees were introduced to a wide variety of urban contexts, from which one can imagine a wide variety of climatic influences are negotiated. From the historic town of Malaga, Spain to the recently revamped waterfront of Wellington, to the rapidly developing Guangzhou, the conference provided a rich context of how and why our cities evolve. This is of importance to urban climatologists opening up research in new regions of the globe or trying to align themselves with a variety of practitioners involved in the development and refurbishment of urban areas. Davis and Brown (University of Oregon, FCB Studios) discussed how older building typologies in Guangzhou are resilient to economic change, adapting the organization of dwelling and commercial units opposed to the rigidity of recent development. Torres (Université de Montréal) presented recent findings on several eco-development projects, their evaluation in design and implementation and how they

display certain impermeability between neighbourhoods by at times focusing solely on connections to the downtown.

Within the Urban Form and Environmental Performance theme, several papers examined the influence of sky view factor on urban climates. Steve Jusuf (National University of Singapore), reporting work undertaken by N.H. Wong and others, presented an animation of the “STEVE” tool – Screening Tool for Estate Environment Evaluation that uses fairly simple inputs related to urban form to predict from empirical relations the maximum and minimum temperatures for tropical cities that are characterized by weak wind conditions. Wind effects in cities were also addressed in several papers, using modelling approaches.

Thermal effects of urban form were examined from a biothermal perspective, from the impact of urban form on sky view factor, and from a land use characteristics approach (using LCZ classification) that showed that some trends in Glasgow were more related to regional climate changes rather than local changes (Kruger & Emmanuel, Glasgow Caledonian University). Conceptual differences in how temperatures can be represented within urban forms – including air temperatures, surface temperatures (defined from different subsets of the total urban surface and from different view points) and measures of temperature related to human comfort were illustrated by Voogt *et al.* (Univ. of Western Ontario).

Another theme within the form and environmental performance stream was related to urban carbon emissions. Approaches ranged from simple measures of urban form related to energy consumption (Zhao *et al.*, Nanjing University) through to the coupled use of airborne lidar derived building form with building energy simulation models to assess carbon emissions from urban buildings (van der Laan *et al.*, University of British Columbia), to direct observations of carbon emissions in four Canadian neighbourhoods (Christen *et al.*, University of British Columbia). These observations provided some insight into urban form and carbon emissions – suburban sites provide the poorest energy efficiency in terms of carbon emissions per person or per building volume – and an indication that urban modelling of carbon emissions are viable. From a more planning/engineering perspective, a site selection framework for commercial building sites to minimize overall greenhouse gas emissions and energy consumption from both the buildings and associated transportation was examined by Weigel (Georgia Institute of Technology). Future climate scenarios were used to examine at the microscale a simplified method for assessing total heat gain through building envelopes and at the city scale to develop a design method for architects to integrate mitigation and adaptation to determine if manipulation of urban form can support greenhouse gas reduction efforts in Quebec City, Canada (Dubois, Université Laval). In the case of Quebec City, the researchers are employing the LCZ concept (see Stewart, 2009) and merging this with socioeconomic information in a GIS framework.

Other papers addressed specific impacts of urban form on environmental characteristics, including factors of urban



morphology that affect the exposure of cyclists to particulate matter, and how urban form influences traffic noise. Research included a mix of modeling and measurement approaches.

In one of six sessions of the conference presented in French with English translation, Messaoud and Musy (École Nationale Supérieure d'Architecture de Nantes) presented urban albedo modeling to provide guidelines to practitioners for surface coatings, roof planting and impacts of roof and wall clad solar panels. This suggested a reframing of the traditional role of climate on building in the architectural field to be reversed and look at the role of the building on local climate. Teller *et al.* advanced large-scale building GHG emissions mapping, modeling an extensive part of Belgium's building stock to relate GHG emissions estimates to both urban density and mobility factors. And finally Qu *et al.* of CERE ENPC/ EDF R&D École des Ponts ParisTech showed some highly detailed numerical simulations of an urban surface using a 3D building resolving code.

Other sessions of potential interest to IAUC members included: “Compact City and Bio-Climatic Dilemmas”, “Morphology and Sustainable Urbanism” and “Planning for Sustainability”. One presentation in the “Compact City and Bio-Climatic Dilemmas” by Clark (University of Colorado, Denver) entitled, “Metropolitan density and energy efficiency: multi-attribute tradeoffs and their policy implications” reiterated the seminal study by Newman and Kenworthy (1991) for a number of American cities, outlining the impact of density on vehicle miles traveled. This area of study has also recently pointed out linkages between personal transportation costs and housing affordability and has policy implications to reduce emissions, congestion in cities and mortgage lending.

The conference ended with a note by Michael Conzen (University of Chicago), President of ISUF, who offered a definition of urban morphology. This seemed to highlight the importance of forging a common language between disciplines as both urban climatology and urban morphology carve out a language that best describes the elements that make up cities.

References

- Stewart, I. (2009) Classifying urban climate field sites by “Local Climate Zones”. *Urban Climate News* 34, 8-11.
- Newman, P.W.G. and Kenworthy, J.R. (1991) Transport and urban form in thirty-two of the world's principal cities. *Transport Reviews* 11(3), 249-272.

Recent publications in Urban Climatology

Alfano, F. R. D. A.; Palella, B. I. & Riccio, G. (2011), The role of measurement accuracy on the thermal environment assessment by means of PMV index, *Building and Environment* 46(7), 1361-1369.

Andrade, H.; Alcoforado, M. J. & Oliveira, S. (2011), Perception of temperature and wind by users of public outdoor spaces: relationships with weather parameters and personal characteristics, *Int J Biometeorol* 55, 665-680.

Benzerzour, M.; Masson, V.; Groleau, D. & Lemonsu, A. (2011), Simulation of the urban climate variations in connection with the transformations of the city of Nantes since the 17th century, *Building and Environment* 46(8), 1545-1557.

Bouyer, J.; Inard, C. & Musy, M. (2011), Microclimatic coupling as a solution to improve building energy simulation in an urban context, *Energy and Buildings* 43(7), 1549-1559.

Braun, B. & Aßheuer, T. (2011), Floods in megacity environments: vulnerability and coping strategies of slum dwellers in Dhaka/Bangladesh, *Natural Hazards* 58, 771-787.

Bu, Z. & Kato, S. (2011), Investigation of Ventilation Effectiveness for Wind-Driven Single-Sided Ventilated Buildings Located in an Urban Environment, *The International Journal of Ventilation* 10(1).

Bueno, B.; Norford, L.; Pigeon, G. & Britter, R. (2011), Combining a Detailed Building Energy Model with a Physically-Based Urban Canopy Model, *Boundary-Layer Meteorology* 140(3), 471-489.

Castillo, M.; Inagaki, A. & Kanda, M. (2011), The Effects of Inner- and Outer-Layer Turbulence in a Convective Boundary Layer on the Near-Neutral Inertial Sublayer Over an Urban-Like Surface, *Boundary-Layer Meteorology* 140(3), 453-469.

Charabi, Y. & Bakhit, A. (2011), Assessment of the canopy urban heat island of a coastal arid tropical city: The case of Muscat, Oman, *Atmospheric Research* 101, 215-227.

Chen, F.; Miao, S.; Tewari, M.; Bao, J. W. & Kusaka, H. (2011), A numerical study of interactions between surface forcing and sea breeze circulations and their effects on stagnation in the greater Houston area, *Journal of Geophysical Research-Atmospheres* 116, D12105.

Chowdhuri, S.; Singh, O. & Majumdar, R. (2011), Site response studies in Agartala Urban agglomeration, *Natural Hazards* 59, 329-345.

Cohen, J. B.; Prinn, R. G. & Wang, C. (2011), The impact of detailed urban-scale processing on the composition, distribution, and radiative forcing of anthropogenic aerosols, *Geophys. Res. Lett.* 38(10), L10808--.

Cullis, J.; Strzepak, K.; Tadross, M.; Sami, K.; Havenga, B.; Gildenhuis, B. & Smith, J. (2011), Incorporating climate change

In this edition a list of publications that have come out until September 2011 are presented; thanks for your numerous contributions. As usual, papers published since November 2011 are welcome for inclusion in the next newsletter and IAUC online database. Please send your references to julia.hidalgo@gmail.com with a header "IAUC publications" and the following format: Author, Title, Journal, Volume, Pages, Dates, Keywords, Language, URL, and Abstract.

Happy reading,

Julia Hidalgo



into water resources planning for the town of Polokwane, South Africa, *Climatic Change* 108, 437-456.

Czarnecka, M.; Makosza, A. & Nidzgorska-Lencewicz, J. (2011), Variability of meteorological elements shaping biometeorological conditions in Szczecin, Poland, *Theoretical and Applied Climatology* 104(1-2), 101--110.

Deb, C. & Ramachandraiah, A. (2011), A simple technique to classify urban locations with respect to human thermal comfort: Proposing the HXG scale, *Building and Environment* 46(6), 1321-1328.

Edussuriya, P.; Chan, A. & Ye, A. (2011), Urban morphology and air quality in dense residential environments in Hong Kong. Part I: District-level analysis, *Atmospheric Environment* 45(27), 4789--4803.

Elagib, N. A. (2011), Evolution of urban heat island in Khartoum, *International Journal of Climatology* 31(9), 1377--1388.

Ferreira, M. J.; de Oliveira, A. P. & Soares, J. (2011), Anthropogenic heat in the city of So Paulo, Brazil, *Theoretical and Applied Climatology* 104(1-2), 43--56.

Fewtrell, T. J.; Neal, J. C.; Bates, P. D. & Harrison, P. J. (2011), Geometric and structural river channel complexity and the prediction of urban inundation, *Hydrological Processes* 25, 3173-3186.

Gladius, M.; la Cour, A. & Lohse, C. (2011), Fossil and non-fossil carbon in fine particulate matter: A study of five European cities, *Journal of Geophysical Research-Atmospheres* 116, D11302.

Gorbarenko, E. & Abakumova, G. (2011), Radiation balance variations of underlying surface from the long-term obser-

- vations of the Meteorological Observatory of the Moscow State University, *Russian Meteorology and Hydrology* 36(6), 383--391.
- Gros, A.; Bozonnet, E. & Inard, C. (2011), Modelling the radiative exchanges in urban areas: A review, *Advances in Building Energy Research* 5(1), 163-206.
- Hajra, B.; Stathopoulos, T. & Bahloul, A. (2011), The effect of upstream buildings on near-field pollutant dispersion in the built environment, *Atmospheric Environment* 45(28), 4930--4940.
- Hang, J. & Li, Y. (2011), Age of air and air exchange efficiency in high-rise urban areas and its link to pollutant dilution, *Atmospheric Environment* 45(31), 5572--5585.
- He, L. Y.; Huang, X. F.; Xue, L.; Hu, M.; Lin, Y.; Zheng, J.; Zhang, R. & Zhang, Y. H. (2011), Submicron aerosol analysis and organic source apportionment in an urban atmosphere in Pearl River Delta of China using high-resolution aerosol mass spectrometry, *Journal of Geophysical Research-Atmospheres* 116, D12304.
- Jeong, J. H.; Ho, C. H.; Linderholm, H. W.; Jeong, S. J.; Chen, D. & Choi, Y. S. (2011), Impact of urban warming on earlier spring flowering in Korea, *International Journal of Climatology* 31(10), 1488--1497.
- Kauhaniemi, M.; Kukkonen, J.; Härkönen, J.; Nikmo, J.; Kangas, L.; Omstedt, G.; Ketzler, M.; Kousa, A.; Haakana, M. & Karppinen, A. (2011), Evaluation of a road dust suspension model for predicting the concentrations of PM10 in a street canyon, *Atmospheric Environment* 45(22), 3646--3654.
- Kershaw, T.; Eames, M. & Coley, D. (2011), Assessing the risk of climate change for buildings: A comparison between multi-year and probabilistic reference year simulations, *Building and Environment* 46(6), 1303-1308.
- Kislov, A. & Konstantinov, P. (2011), Detailed spatial modeling of temperature in Moscow, *Russian Meteorology and Hydrology* 36(5), 300--306.
- Kuhlicke, C.; Scolobig, A.; Tapsell, S.; Steinführer, A. & De Marchi, B. (2011), Contextualizing social vulnerability: findings from case studies across Europe, *Natural Hazards* 58, 789-810.
- Kwak, K.; Baik, J.; Lee, S. & Ryu, Y. (2011), Computational Fluid Dynamics Modelling of the Diurnal Variation of Flow in a Street Canyon, *Boundary-Layer Meteorology* 141(1), 77-92.
- Lee, S. (2011), Further Development of the Vegetated Urban Canopy Model Including a Grass-Covered Surface Parametrization and Photosynthesis Effects, *Boundary-Layer Meteorology* 140(2), 315-342.
- Li, D. H.; Wan, K. K.; Yang, L. & Lam, J. C. (2011), Heat and cold stresses in different climate zones across China: A comparison between the 20th and 21st centuries, *Building and Environment* 46(8), 1649-1656.
- Li, W.; Zhou, S.; Wang, X.; Xu, Z.; Yuan, C.; Yu, Y.; Zhang, Q. & Wang, W. (2011), Integrated evaluation of aerosols from regional brown hazes over northern China in winter: Concentrations, sources, transformation, and mixing states, *Journal of Geophysical Research-Atmospheres* 116, D09301.
- Lianou, M.; Chalbot, M.; Kavouras, I.; Kotronarou, A.; Karakatsani, A.; Analytis, A.; Katsouyanni, K.; Puustinen, A.; Hameri, K.; Vallius, M.; Pekkanen, J.; Meddings, C.; Harrison, R.; Ayres, J.; Brick, H.; Kos, G.; Meliefste, K.; de Hartog, J. & Hoek, G. (2011), Temporal variations of atmospheric aerosol in four European urban areas, *Environmental Science and Pollution Research* 18(7), 1202-1212.
- Linden, J. & Holmer, B. (2011), Thermally induced wind patterns in the Sahelian city of Ouagadougou, Burkina Faso, *Theoretical and Applied Climatology* 105(1-2), 229--241.
- Liu, C. H.; Cheng, W. C.; Leung, T. C. Y. & Leung, D. Y. C. (2011), On the mechanism of air pollutant re-entrainment in two-dimensional idealized street canyons, *Atmospheric Environment* 45(27), 4763--4769.
- Machado, A. J. (2011), Analysis of the radiative balance in Queiroz Filho Avenue - São Paulo, Brazil under clear sky condition during the dry season, *Geogra a: Ensino & Pesquisa* v.15(1), 7-16 (Language: portuguese).
- Minoura, H. & Shimo, N. (2011), Spatial distribution of particle number concentration and its volume change in the planetary boundary layer over Tokyo and its suburban areas, *Atmospheric Environment* 45(27), 4603--4610.
- Mishra, V. & Lettenmaier, D. P. (2011), Climatic trends in major U.S. urban areas, 1950-2009, *Geophys. Res. Lett.* 38(16), L16401--.
- Murena, F.; Di-Benedetto, A.; D'Onofrio, M. & Vitiello, G. (2011), Mass Transfer Velocity and Momentum Vertical Exchange in Simulated Deep Street Canyons, *Boundary-Layer Meteorology* 140(1), 125-142.
- Murphy, D. J.; Hall, M. H.; Hall, C. A. S.; Heisler, G. M.; Stehman, S. V. & Anselmi-Molina, C. (2011), The relationship between land cover and the urban heat island in northeastern Puerto Rico, *International Journal of Climatology* 31(8), 1222--1239.
- Nagano, K. & Horikoshi, T. (2011), New index indicating the universal and separate effects on human comfort under outdoor and non-uniform thermal conditions, *Energy and Buildings* 43(7), 1694-1701.
- Nelson, M.; Pardyjak, E. & Klein, P. (2011), Momentum and Turbulent Kinetic Energy Budgets Within the Park Avenue Street Canyon During the Joint Urban 2003 Field Campaign, *Boundary-Layer Meteorology* 140(1), 143-162.
- Nicholls, N. & Larsen, S. (2011), Impact of drought on temperature extremes in Melbourne, Australia, *Australian Meteorological and Oceanographic Journal* 61, 113-116.
- Nunez, M.; Marin, M. J.; Utrillas, M. P.; Estelles, V. & Martinez-Lozano, J. A. (2011), Incorporation of aerosol effects

- in a clear-sky semi-empirical model of UVER radiation for Valencia, Spain, *International Journal of Climatology* 31(6), 937--948.
- Pagliarini, G. & Rainieri, S. (2011), Thermal environment characterisation of a glass-covered semi-outdoor space subjected to natural climate mitigation, *Energy and Buildings* 43(7), 1609-1617.
- Parshutkina, I.; Sosnikova, E.; Grishina, N.; Stulov, E.; Plaude, N. & Monakhova, N. (2011), Atmospheric aerosol characterization in 2010 anomalous summer season in the Moscow region, *Russian Meteorology and Hydrology* 36(6), 355--361.
- Petralli, M.; Massetti, L. & Orlandini, S. (2011), Five years of thermal intra-urban monitoring in Florence (Italy) and application of climatological indices, *Theoretical and Applied Climatology* 104(3-4), 349--356.
- Poelmans, L.; Rompaey, A. V.; Ntegeka, V. & Willems, P. (2011), The relative impact of climate change and urban expansion on peak flows: a case study in central Belgium, *Hydrological Processes* 25, 2846-2858.
- Pontiggia, M.; Landucci, G.; Busini, V.; Derudi, M.; Alba, M.; Scaioni, M.; Bonvicini, S.; Cozzani, V. & Rota, R. (2011), CFD model simulation of LPG dispersion in urban areas, *Atmospheric Environment* 45(24), 3913--3923.
- Praskievicz, S. & Chang, H. (2011), Impacts of Climate Change and Urban Development on Water Resources in the Tualatin River Basin, Oregon, *Annals of the Association of American Geographers* 101(2), PII 933400604.
- Ramier, D.; Berthier, E. & Andrieu, H. (2011), The hydrological behaviour of urban streets: long-term observations and modelling of runoff losses and rainfall-runoff transformation, *Hydrological Processes* 25, 2161-2178.
- Roy, S. S.; Singh, R. B. & Kumar, M. (2011), An Analysis of Local Spatial Temperature Patterns in The Delhi Metropolitan Area, *Physical Geography* 32, 114-138.
- Ryder, C. & Toumi, R. (2011), An urban solar flux island: Measurements from London, *Atmospheric Environment* 45(20), 3414--3423.
- Sahu, L. K.; Kondo, Y.; Miyazaki, Y.; Pongkiatkul, P. & Oanh, N. T. K. (2011), Seasonal and diurnal variations of black carbon and organic carbon aerosols in Bangkok, *Journal of Geophysical Research-Atmospheres* 116, D15302.
- Shashua-Bar, L.; Pearlmutter, D. & Erell, E. (2011), The influence of trees and grass on outdoor thermal comfort in a hot-arid environment, *International Journal of Climatology* 31(10), 1498--1506.
- Shimazaki, Y.; Yoshida, A.; Suzuki, R.; Kawabata, T.; Imai, D. & Kinoshita, S. (2011), Application of human thermal load into unsteady condition for improvement of outdoor thermal comfort, *Building and Environment* 46(8), 1716-1724.
- Solazzo, E.; Vardoulakis, S. & Cai, X. (2011), A novel methodology for interpreting air quality measurements from urban streets using CFD modelling, *Atmospheric Environment* 45(29), 5230--5239.
- Stromann-Andersen, J. & Sattrup, P. (2011), The urban canyon and building energy use: Urban density versus daylight and passive solar gains, *Energy and Buildings* 43(8), 2011-2020.
- Takimoto, H.; Sato, A.; Barlow, J.; Moriwaki, R.; Inagaki, A.; Onomura, S. & Kanda, M. (2011), Particle Image Velocimetry Measurements of Turbulent Flow Within Outdoor and Indoor Urban Scale Models and Flushing Motions in Urban Canopy Layers, *Boundary-Layer Meteorology* 140(2), 295-314.
- Vardoulakis, S.; Solazzo, E. & Lumberras, J. (2011), Intra-urban and street scale variability of BTEX, NO₂ and O₃ in Birmingham, UK: Implications for exposure assessment, *Atmospheric Environment* 45(29), 5069--5078.
- Walker, S. L. (2011), Building mounted wind turbines and their suitability for the urban scale—A review of methods of estimating urban wind resource, *Energy and Buildings* 43(8), 1852-1862.
- Wang, M.; Markert, B.; Shen, W.; Chen, W.; Peng, C. & Ouyang, Z. (2011), Microbial biomass carbon and enzyme activities of urban soils in Beijing, *Environmental Science and Pollution Research* 18(6), 958-967.
- Williams, M.; Cornford, D.; Bastin, L.; Jones, R. & Parker, S. (2011), Automatic processing, quality assurance and serving of real-time weather data, *Computers & Geosciences* 37(3), 353-362.
- Xie, Z. (2011), Modelling Street-Scale Flow and Dispersion in Realistic Winds—Towards Coupling with Mesoscale Meteorological Models, *Boundary-Layer Meteorology* 141(1), 53-75.
- Yang, X.; Hou, Y. & Chen, B. (2011), Observed surface warming induced by urbanization in east China, *Journal of Geophysical Research-Atmospheres* 116, D14113.
- Yassin, M. F. (2011), Impact of height and shape of building roof on air quality in urban street canyons, *Atmospheric Environment* 45(29), 5220--5229.
- Yin, S.; Li, W.; Chen, D.; Jeong, J. H. & Guo, W. (2011), Diurnal variations of summer precipitation in the Beijing area and the possible effect of topography and urbanization, *Advances in Atmospheric Sciences* 28, 725-734.
- Zhang, Y. W.; Gu, Z. L.; Cheng, Y. & Lee, S. C. (2011), Effect of real-time boundary wind conditions on the air flow and pollutant dispersion in an urban street canyon—Large eddy simulations, *Atmospheric Environment* 45(20), 3352--3359.
- Zhao, X.; Zhang, X.; Pu, W.; Meng, W. & Xu, X. (2011), Scattering properties of the atmospheric aerosol in Beijing, China, *Atmospheric Research* 101, 799-808.
- (2011), Special Issue: Sea Level Rise in Florida: An Emerging Ecological and Social Crisis, *Climatic Change* 107(1-2).

Upcoming Conferences...

"CLIMATE AND CONSTRUCTIONS" CONFERENCE AND WORKSHOPS

Karlsruhe, Germany • October 24-25, 2011
<http://www.kit.edu>

5TH KOREA-JAPAN-CHINA JOINT CONFERENCE ON METEOROLOGY, Boundary-Layer Session

Busan, Korea • October 24-26, 2011
<http://www.komes.or.kr/5th-kjc-jcm-2011/>

BRIDGE SUSTAINABLE URBAN PLANNING CONFERENCE

Brussels, Belgium • October 26, 2011
<http://www.liaise-noe.eu/~conference>

WORLD RENEWABLE ENERGY ASIA REGIONAL CONGRESS AND EXHIBITION

Chongqing, China • October 28-31, 2011
<http://www.wrenuk.co.uk/index.html>

TRAINING WORKSHOP ON URBAN RESPONSE TO CLIMATE CHANGE IN ASIA

National Taipei Univ. Taiwan • November 10-15, 2011
<http://www.sarcs.org/~Urban.htm>

FRIENDLY CITY 3 INTERNATIONAL CONFERENCE: CREATING URBAN ARCHITECTURE FOR A BETTER LIFE

Medan, N. Sumatra, Indonesia • November 16-17, 2011
<http://mta.usu.ac.id/call-for-paper.html>

URBAN METABOLISM AND DYNAMICS OF URBANIZATION, special session at AGU FALL MEETING

San Francisco CA, USA • December 5-9, 2011
<http://sites.agu.org/fallmeeting>

URBAN CLIMATOLOGY FOR TROPICAL & SUB-TROPICAL REGIONS

Chinese University, Hong Kong • December 5-10, 2011
<http://www.arch.cuhk.edu.hk/asi2011>

PUBLIC OPEN SPACES IN THE SUSTAINABLE CITY: LIVABILITY, ENVIRONMENT AND ECONOMY

Ben-Gurion University, Israel • Decembr 19-22, 2011
<http://www.bgu.ac.il/CDAUP/POS-workshop.pdf>

SOUTH ASIAN CITIES – COPING WITH FUTURE ENVIRONMENTAL CHANGES, session at AAG 2012

New York, NY • February 24-28, 2012
<http://www.aag.org/annualmeeting>

URBAN AREAS: IMPACT OF EXTREME WEATHER EVENTS, session at AAG 2012

New York, NY • February 24-28, 2012
<http://www.aag.org/annualmeeting>

8TH INTERNATIONAL CONFERENCE ON AIR QUALITY – SCIENCE AND APPLICATION

Athens, Greece • March 19-23, 2012
<http://www.airqualityconference.org>

FIRST INTERNATIONAL CONFERENCE ON BUILDING SUSTAINABILITY ASSESSMENT

Porto, Portugal • May 23-25, 2012
<http://www.bsa2012.org>

INTERNATIONAL CONFERENCE ON URBAN CLIMATES (ICUC8)

Dublin, Ireland • August 6-10, 2012
<http://www.icuc8.org>



International
Society of
Biometeorology

<http://www.icb2011.com>



19th International Congress of Biometeorology

4 - 8 December 2011, The University of Auckland, New Zealand



The 8th International Conference on Urban Climates (ICUC8) August 6th-10th, 2012 in Dublin, Ireland

Colleagues, preparations are well underway for the **8th International Conference on Urban Climates (ICUC8)**, which will be held in Dublin from **6th-10th August, 2012**. This event is being organised by the IAUC and being jointly held with a meeting of the Board of the Urban Environment, a speciality group of the American Meteorological Society. We hope that about 400 delegates from around the world will join us in Dublin to discuss the climates of cities.

The conference website is at www.icuc8.org and the call for abstracts is now open. On the website you are asked to register your interest in the conference so that you will receive regular updates in the form of a short conference Newsletter. The information in this publication will be confined to the ICUC8 itself and will be of a more general nature than any-

thing published in *Urban Climate News*. We would ask IAUC members to register interest in ICUC8 on the website so that we can monitor the progress of the event. The abstract submissions will remain open until 31 December 2011. Once the submission period is completed, a scientific panel will review the abstracts and decide on the precise themes of ICUC8 including the distribution of papers and posters. This process should be completed by 1 February, 2012. At that point the authors will be informed and papers can be submitted for publication in a set of proceedings. Registration for the conference will open on 1 January, 2012.

The general structure of ICUC8 has been established at this stage and we are awaiting the completion of the abstract submission period to formalise sessions and decide upon plenary events. The basic



View of Dublin City Centre

structure of ICUC8 will follow the format of previous events at Łódz (Poland), Göteborg (Sweden) and Yokohama (Japan). It will take place over five days and take place on the campus of University College Dublin (UCD), which is located about 5km south of the city centre.

Previous ICUC events have been marked by a convivial atmosphere where academic discussions are complemented by social events. ICUC8 will endeavour to maintain this tradition by hosting an opening reception, a civic reception in central Dublin and organising a conference dinner. In addition, there will be a full programme of supporting events during the daytime to occupy those travelling with delegates. These will include field-trips to the city centre and to places of historic and cultural interest in the surrounding countryside. Dublin has a very healthy night-life that includes music events, pubs and theatres. Moreover, it is a relatively small city that is easy to navigate using the public transport system and to access other parts of the country.

The Local Organising Committee.

ICUC8 in Dublin, August 2012

An initial schedule of the key conference dates is presented below. In the coming months, more details will be presented through the pages of *Urban Climate News* and via the IAUC website. The conference website is www.icuc8.org and this will be regularly updated in the coming months.

First call for papers	July 31
Second call for papers	October 31
Closing date for submission of abstracts	January 31
Abstract review by Scientific Committee	February 31
Extended abstract deadline	May 31
Early online registration	March 31 - May 1
Late registration	June 1 - July 15

Conference Website: www.icuc8.org

Board Members & Terms

- Toshiaki Ichinose (National Institute for Environmental Studies, Japan): 2007-2011
- Rohinton Emmanuel (Glasgow Caledonian University, UK): 2006-2010; Secretary, 2009-2011
- Petra Klein (University of Oklahoma, USA): 2007-2011
- Sue Grimmond (King's College London, UK): 2000-2003; President, 2003-2007; Past President, 2007-2009*
- Manabu Kanda (Tokyo Institute of Technology, Japan): 2005-2009, ICUC-7 Local Organizer, 2007-2009.*
- Sofia Thorsson (University of Gothenburg, Sweden): 2008-2012
- Gerald Mills (UCD, Dublin, Ireland): 2007-2011; President, 2009-2011
- Tim Oke (University of British Columbia, Canada): President, 2000-2003; Past President, 2003-2006; Emeritus President 2007-2009*
- Matthias Roth (National University of Singapore, Singapore): 2000-2003; Secretary, 2003-2007; Acting-Treasurer 2006; President, 2007-2009; Past-President 2009-2011*
- Jennifer Salmond (University of Birmingham, UK): 2005-2009; Secretary, 2007-2009
- James Voogt (University of Western Ontario, Canada), 2000-2006; Webmaster 2007-2009; 2009-2013
- Jason Ching (EPA Atmospheric Modelling & Analysis Division, USA): 2009-2013
- Alberto Martilli (CIEMAT, Spain), 2010-2014
- Aude Lemonsu (CNRS/Meteo France), 2010-2014
- Silvana di Sabatino (Univ. of Salento, Italy), 2010-2014
- David Pearlmutter (Ben-Gurion University of the Negev, Israel): Newsletter Editor, 2009-*

* appointed members

IAUC Committee Chairs

Editor IAUC Newsletter: David Pearlmutter
 Bibliography Committee: Julia Hidalgo
 Membership Committee: TBA
 Nominating Committee: Tim Oke
 Int. Representative Committee: TBA
 Chair Teaching Resources: Gerald Mills
 Interim-Chair Awards Committee: Jennifer Salmond
 WebMaster: James Voogt

Newsletter Contributions

The next edition of *Urban Climate News* will appear in late December. Items to be considered for the upcoming issue should be received by **November 31, 2011** and may be sent to editor David Pearlmutter (davidp@bgu.ac.il) or to the relevant section editor:

News: Winston Chow (wchow@asu.edu)

Conferences: Jamie Voogt (javoogt@uwo.ca)

Bibliography: Julia Hidalgo (julia.hidalgo@gmail.com)

Projects: Sue Grimmond (Sue.Grimmond@kcl.ac.uk)

General submissions should be short (1-2 A4 pages of text), written in a manner that is accessible to a wide audience, and incorporate figures and photographs. Images you think would be of interest to the IAUC community are welcome.